

COLD WATER CABINET FLOOR STAND/ CASTER WHEELS

ASSEMBLY AND INSTALLATION INSTRUCTIONS

Kits #9.801-034.0 & #9.801-035.0

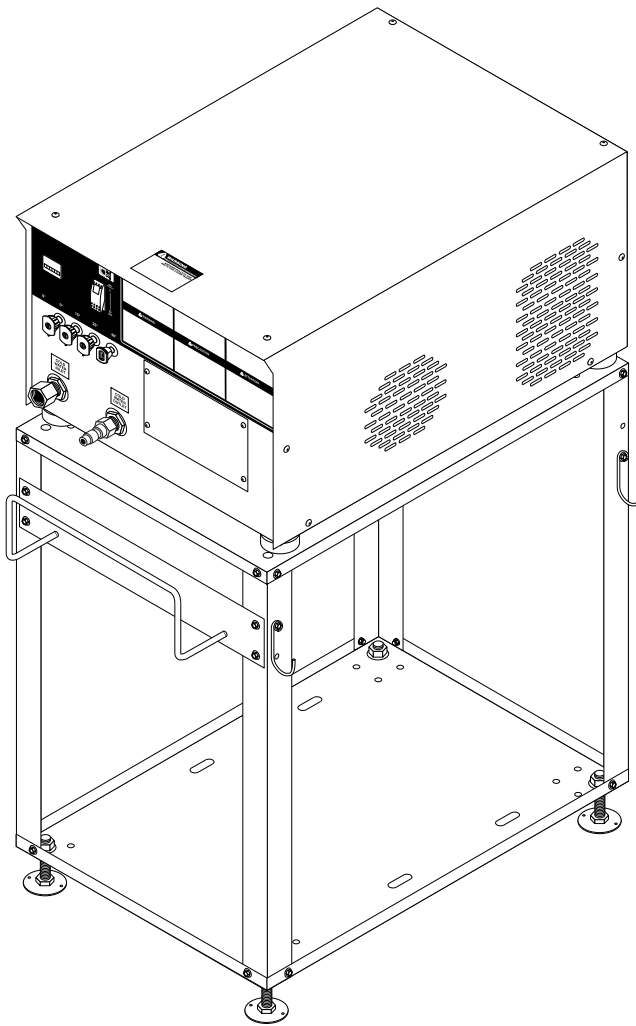

Step 1

Place one (1) panel with the flange up onto the work surface.

Step 2

Assemble 1/2" nut onto leveling foot and adjust to midway on the leveling foot. Repeat for the other 3 leveling feet then insert the leveling feet assemblies up through the 1/2" diameter holes in the bottom panel. Install the remaining 1/2" nuts onto the leveling feet and tighten securely.

Step 3

Position the legs of the stand in corners of the bottom panel and attach with two (2) 1/4" x 1/2" screws in each leg. The ends of the legs with the six (6) holes must be installed up.

Step 4

Place the top panel onto the four (4) legs and attach with two (2) 1/4" x 1/2" screws through each leg. Check stand for squareness and tighten all of the screws securely.

Step 5

Position hose hanger bracket on one end of the stand and attach with four (4) 1/4" x 1/2" screws.

Step 6

Attach one (1) wand holder to each end of the one side of the stand with 1/4" x 3/4" screws.

Step 7

Check stand for levelness and adjust leveling feet as required and carefully inspect stand to verify that it is stable and rigid.

Step 8

Carefully set the pressure washer onto the pressure washer stand. Fasten to top panel with 3/8" x 2" bolts supplied. See Operator's Manual floor set-up procedures.

CABINET EXPLODED VIEW

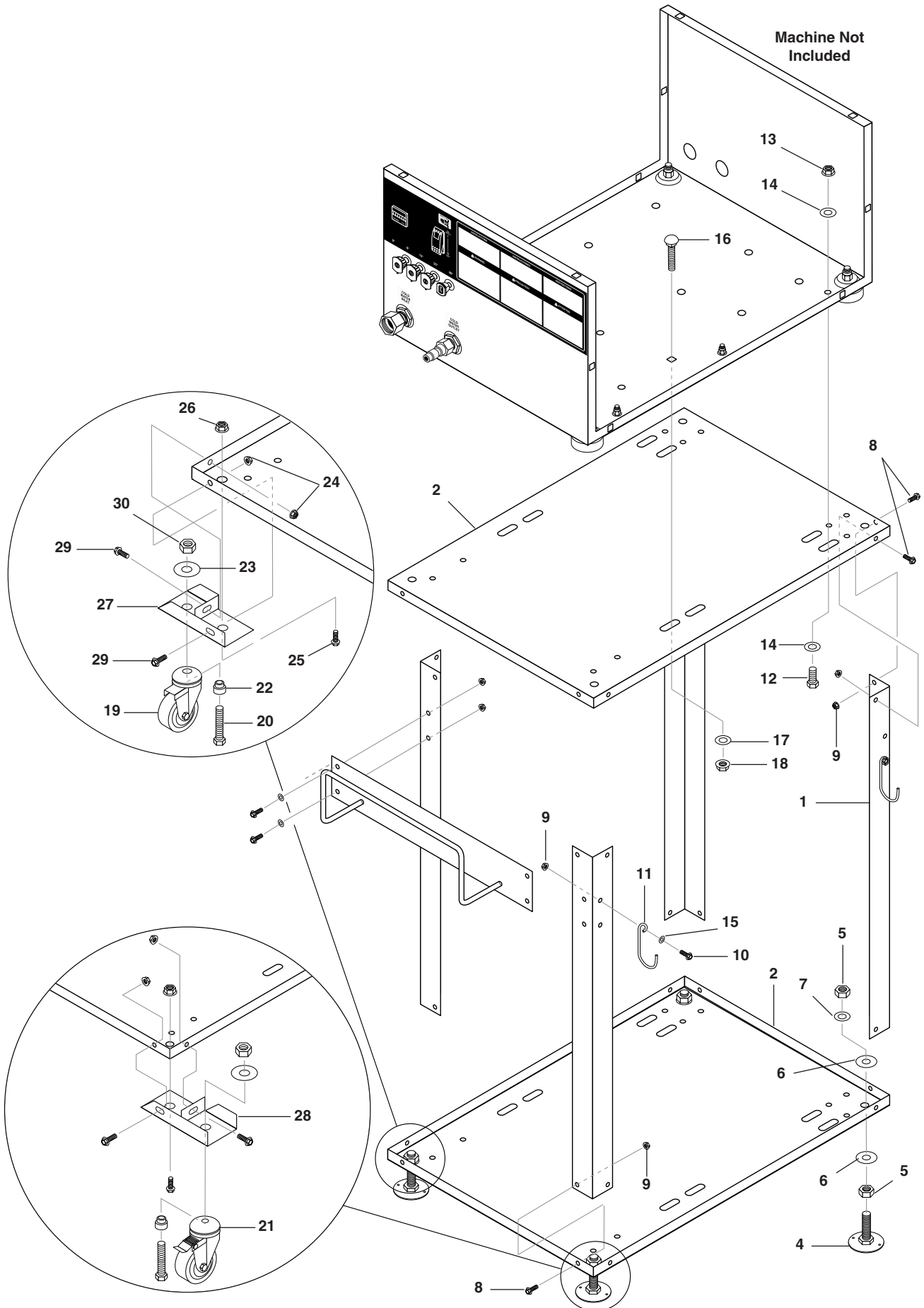

FLOOR STAND PARTS LIST

Kit #9.801-034.0

ITEM	PART NO.	DESCRIPTION	QTY
1	9.803-087.0	Leg, Floor Stand	4
2	9.803-088.0	Panel, Top/Bottom, Floor Stand	2
3	9.803-089.0	Bracket, Hose Hanger, Floor Stand	1
4	9.803-138.0	Foot, Leveling SJ/HBG/HBE	4
5	9.802-790.0	Nut, 1/2" HEX, NC	8
6	9.802-809.0	Washer, 1/2" Flat SAE	8
7	9.803-517.0	Washer, 1/2" Lock	4
8	9.802-754.0	Screw, 1/4" x 1/2" HH NC, Whiz Loc	20
9	9.802-778.0	Nut, 1/4" Flange, ZN	22
10	9.802-753.0	Screw, 1/4" x 3/4" HH, NC, Whiz Loc	2
11	8.719-968.0	Holder, Wand, VHW/VHP, Zinc Plated	2
12	9.802-728.0	Bolt, 3/8" x 2", NC HH"	2
13	9.802-779.0	Nut, 3/8", ESNA, NC	2
14	9.802-807.0	Washer, 3/8" SAE, Flat	4
15	9.802-802.0	Washer, 1/4" Flat, SAE	2
16	9.803-515.0	Bolt, 5/16" x 2", Carriage	2
17	9.802-804.0	Washer, 5/16" Flat, SAE	2
18	9.802-776.0	Nut, 5/16" ESNA, NC	2

CASTER WHEEL PARTS LIST

Kit #9.801-035.0

ITEM	PART NO.	DESCRIPTION	QTY
19	9.802-275.0	Caster Wheel	2
20	9.802-736.0	Bolt, 1/2" x 1-1/2" NC HH Zinc	4
21	9.802-276.0	Caster w/Brake	2
22	8.753-955.0	1/2" Reducer, Bushing	4
23	9.802-800.0	1/2" Washer, Flat	4
24	9.802-775.0	Nut, 1/4" Flange, Zinc	8
25	9.802-767.0	Screw, 3/8" x 3/4" HH, NC, Whiz	4
26	9.802-781.0	Nut, 3/8" Flange, Whiz Loc, NC	4
27	9.803-072.0	Bracket, Left Caster Mount	2
28	9.803-073.0	Bracket, Right Caster Mount	2
29	9.802-753.0	Screw, 1/4" x 3/4"	2
30	9-802-790.0	Nut, 1/2"	4